

Series	HG Series
Block Type	Flange Type
Model Size	65
Load Type	Heavy Load
Block Mounting	Mounting from Top
Block	Standard Block
Preload Class	Medium Preload (0.05 ~ 0.07C)
Precision Code	C
Dust Protection	Standard protection (End seal and bottom seal)

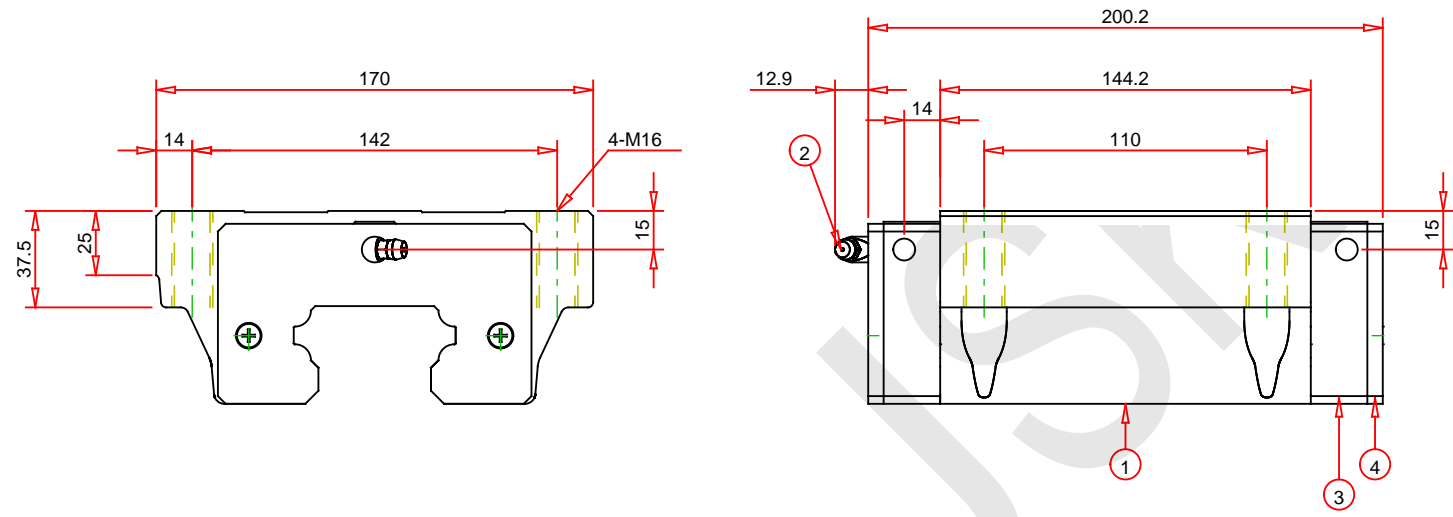

4	End Seal	2
3	End Cap	2
2	Grease Nipple	1
1	Block	1
No.	Part Name	Qty

Notes :
 - Drawing not to scale
 - Dimensions subject to change without notice

Part No. :
 HGW65CAZAC

Description :
 HG Series - Interchangeable Type - Block

HIWIN
 Motion Control and System Technology

Hiwin Technologies Corp.

Address : No. 7, Jingke Road
 Taichung Precision Machinery Park
 Taichung 40852, Taiwan

Tel. : +86 25 68021803
 Email : sales@njskt.com
 Web : www.njskt.com