

Series	EG Series
Block Type	Square Type
Model Size	35
Load Type	Medium Load
Block Mounting	Mounting from Top
Block	Standard Block
Preload Class	Light Preload (0 ~ 0.02C)
Precision Code	C
Dust Protection	Standard protection (End seal and bottom seal)

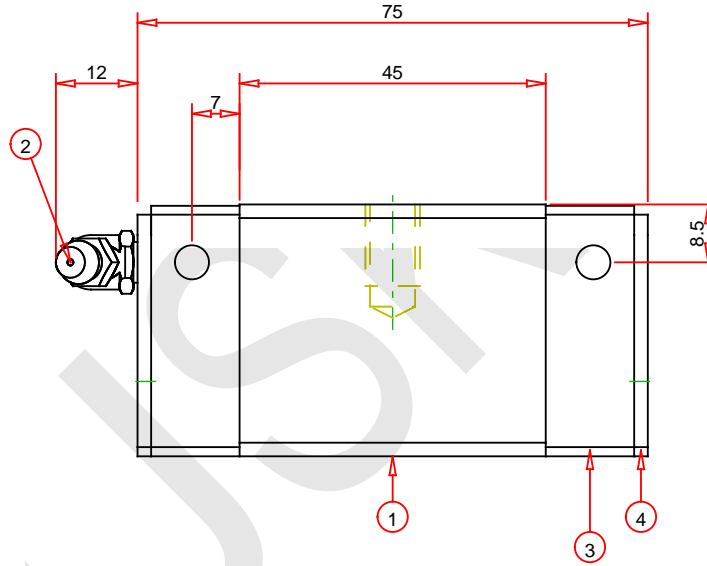
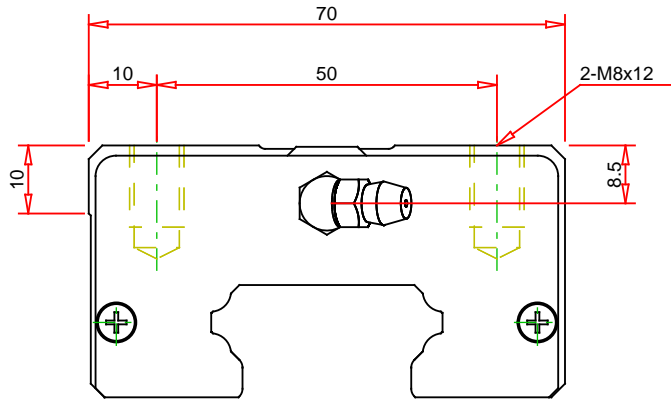

7	0	1
4	End Seal	2
3	End Cap	2
2	Grease Nipple	1
1	Block	1
No.	Part Name	Qty

Notes : - Drawing not to scale
- Dimensions subject to change without notice

Part No. :

EGH35SAZ0C

Description :

EG Series - Interchangeable Type - Block

HIWIN
Motion Control and System Technology

Hiwin Technologies Corp.

Address : No. 7, Jingke Road
Taichung Precision Machinery Park
Taichung 40852, Taiwan
Tel. : +86 25 68021803
Email : sales@njskt.com
Web : www.njskt.com